

Photometric

## iFLEXTUBE DIFF FILM WHITE ESSENTIAL

Protected against environmental influences with diffused high performance silicone encapsulation. Impressive color consistency with 3-step MacAdam ellipses. High quality LED package selected for extended lifetime, efficiency and outstanding light quality.

### PRODUCT FEATURES

 Beam Angle 120°C	 Flame Resistant	 IP Protection	 Saltwater Resistant	 Solvent Resistant	 IK04	 UV Resistant	 LM-79	
 Splash Proof IP65	 Warranty 3 year	 Storage Temperature -40° to 70°C	 Operating Temperature -30° to 45°C	 Color Bin SDCM3	 Lifetime up to 50,000 hours	 Lighting design IES	 Cuttable	 Single end 5m

### SPECIFICATION

Colour	2700 K, 3000 K, 4000 K, 5000 K, 6500 K (Can custom)
Spool length	5 meter
Beam Angle	120°
Max Fixture Runs	5 meter, 1 spool maximum
Dimming Protocol	DMX/RDM (0-100%), 0-10V (10-100%), or DALI (0-100%) via iFlexpower Driver Series
Operating Voltage	24 VDC
Lumen Maintenance	L70 @ 50,000 hours (25° C)
Mounting	3M VHB adhesive backing included, optional aluminium profile
Housing	Silicon
Operating Temperature	-30° C to 45° C

All rights reserved. iFLEXTUBE is a registered trademark of LuxBalance Lighting Limited in various countries. Due to continuous improvement and innovation, specifications may change without notice.

IP Rating	IP65
IK Rating	IK04
Fixture Connectors	Terminal wires
Warranty	3 years standard, 5 years optional
Weight	0.5 kg per reel of 5 m
Dimensions	W 12 x H 5 x L 5000 mm



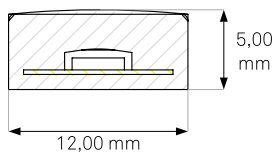
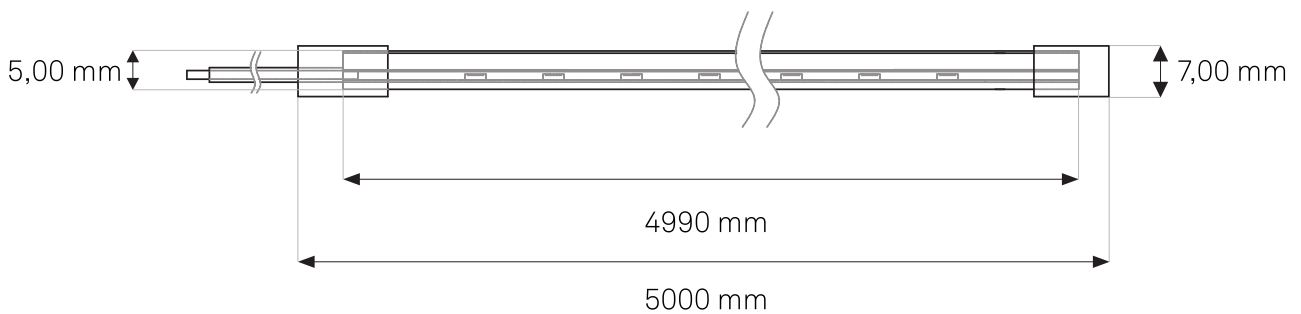

PRODUCT TYPE

Colour CCT	Voltage	LED QTY/M	Wattage	Lumen/M	Lumen Efficiency	CRI	Pitch (mm)
6500 K	24 V	96	12 W/M	1120	93.3 Lm/W	85	10.42
5000 K	24 V	96	12 W/M	1120	93.3 Lm/W	85	10.42
4000 K	24 V	96	12 W/M	1120	93.3 Lm/W	85	10.42
3000 K	24 V	96	12 W/M	900	75 Lm/W	85	10.42
2700 K	24 V	96	12 W/M	900	75 Lm/W	85	10.42

DIMENSIONS



AVAILABLE

-  Power supplies
-  Cables
-  Connectors
-  Profile

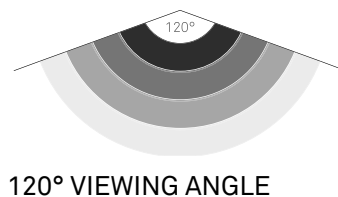

INSTALLATION ACCESSORIES



LFT-C12C45 (LA-LP12A)

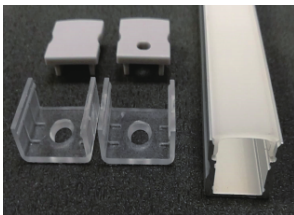
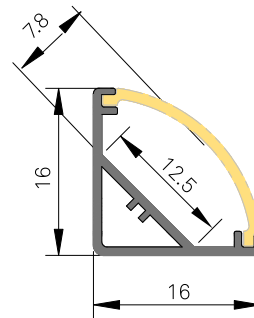

LFT-C12FL (LA-LP13)

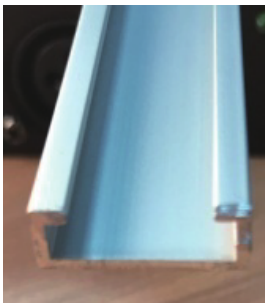
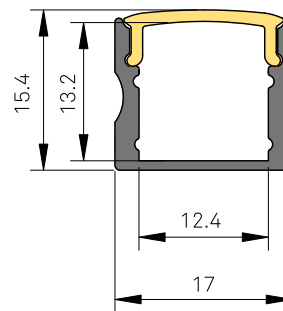

LFT-C12TH

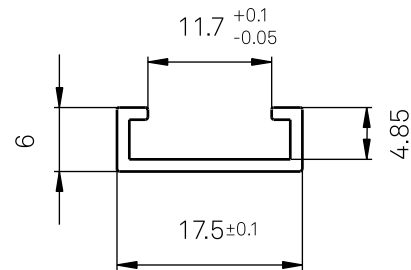

Standard accessories

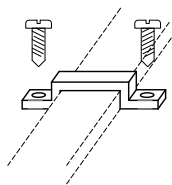

Clip



Feed Cap



End Cap



Glue

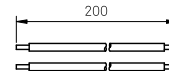

Wire